

Stone Coated Metal Roof Panels

Metstar F-Series

Tile FR

Shake FW

Slate FD

DaVinci FV

Tile 2 FV

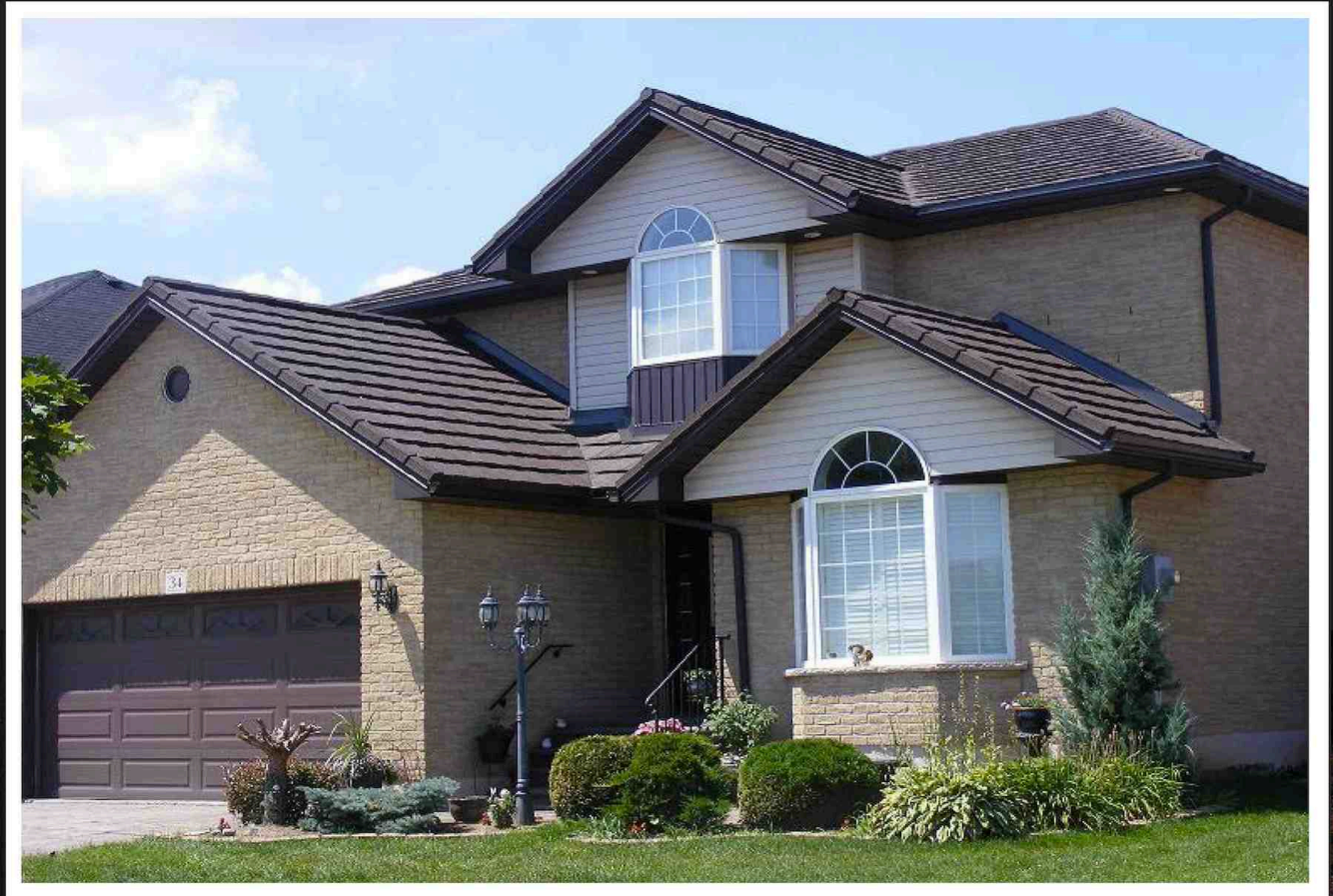



Tile FR
METSTAR™



**Tile FR
Red**

Tile FR Spec

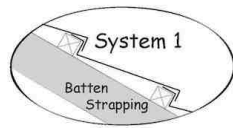

- Overall Length 1340 mm 52 3/4"
- Length of Cover 1280 mm 50 3/8"
- Width of Cover 370 mm 14 9/16"
- Upstand Backshelf 25 mm 1"
- Panel Cover .473 m2 5.1 sq.ft.
- Panels 2.1 / m2 19.6 / SQ
- Weight per Panel 2.7 kg 5.9 lbs.



Red 2090

Brown 2031

Charcoal 2080



Shake FW Brown



Shake FW Spec

•Overall Length	1340 mm	52 3/4"
•Length of Cover	1280 mm	50 3/8"
•Width of Cover	370 mm	14 9/16"
•Upstand Backshelf	25 mm	1"
•Panel Cover	.473 m ²	5.1 sq.ft.
•Panels	2.1 / m ²	19.6 / SQ
•Weight per Panel	2.7 kg	5.9 lbs.

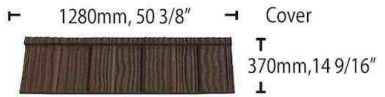
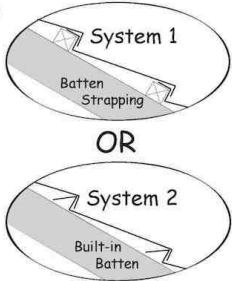

Brown 2031 Charcoal 2080 Teak 2040

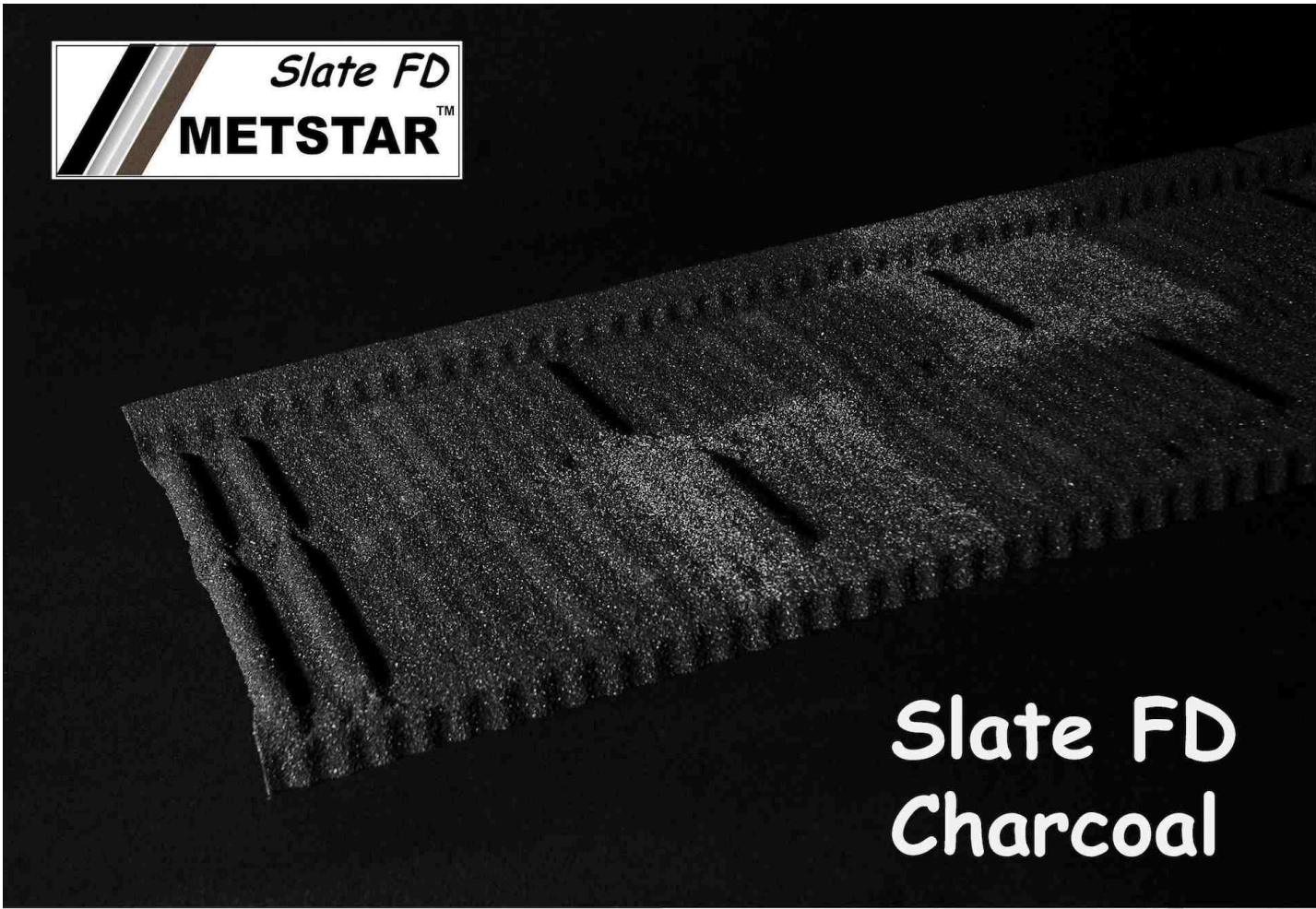

Slate FD Charcoal

Slate FD Spec

•Overall Length	1340 mm	52 3/4"
•Length of Cover	1280 mm	50 3/8"
•Width of Cover	370 mm	14 9/16"
•Upstand Backshelf	25 mm	1"
•Panel Cover	.473 m2	5.1 sq.ft.
•Panels	2.1 / m2	19.6 / SQ
•Weight per Panel	2.7 kg	5.9 lbs.

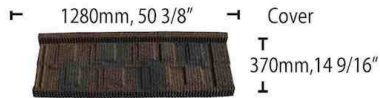
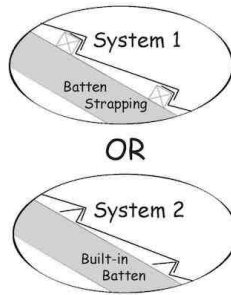

Charcoal/ Grey

Sienna 30SE

Sand





DaVinci FV Tuscany

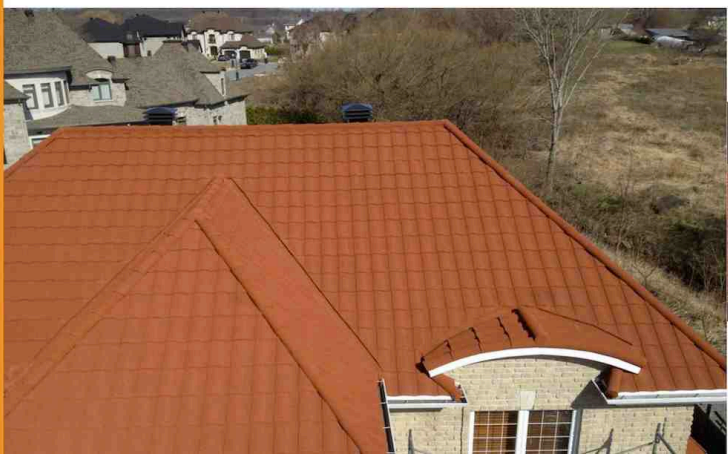

DaVinci FV Spec

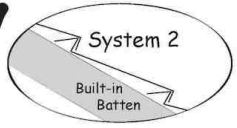

- Overall Length 1285 mm 50 5/8"
- Length of Cover 1215 mm 47 7/8"
- Width of Cover 365 mm 14 3/8"
- Upstand Backshelf 25 mm 1"
- Panel Cover .443 m2 4.8 sq.ft.
- Panels 2.25 / m2 21 / SQ
- Weight per Panel 2.7 kg 5.9 lbs.



Tuscan 30TS Sienna 30SE Brick 0321

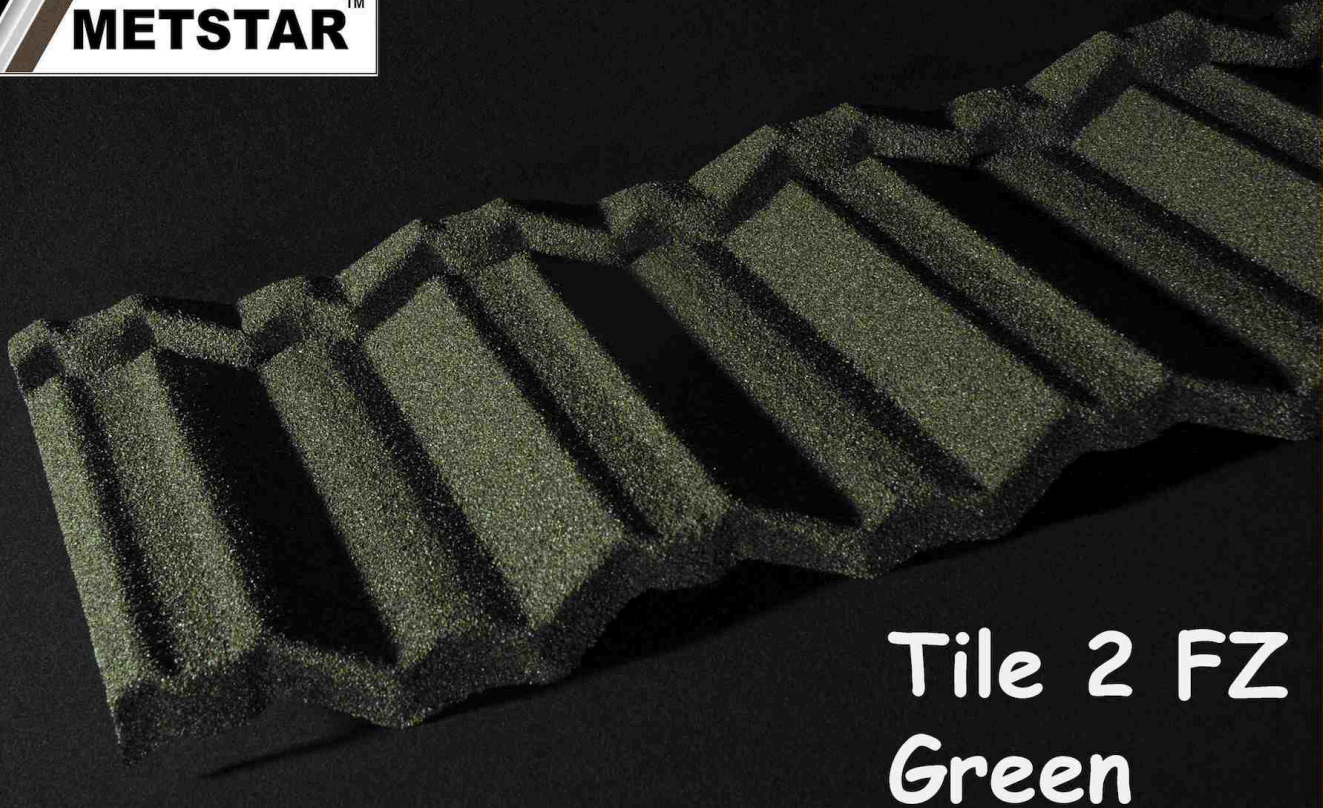

Tile 2 FZ Green

Tile 2 FZ Spec

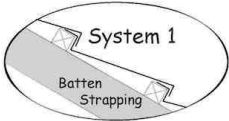

- Overall Length 1340 mm 52 3/4"
- Length of Cover 1280 mm 50 3/8"
- Width of Cover 370 mm 14 9/16"
- Upstand Backshelf 25 mm 1"
- Panel Cover .473 m² 5.1 sq.ft.
- Panels 2.1 / m² 19.6 / SQ
- Weight per Panel 2.7 kg 5.9 lbs.

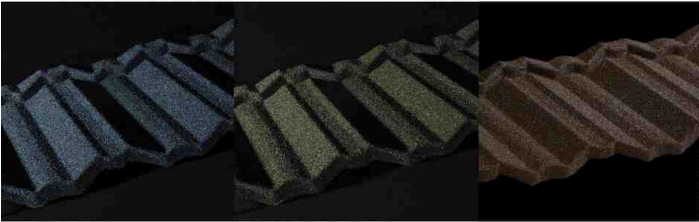

Blue 2070 Green 2011 Brown 2031

End Disc Round



End Disc Trim

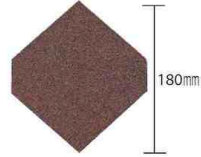

Touch-Up Kit



Barrel Hip & Ridge

Overall length 400 mm, 15.75 in.
Length of cover 370 mm, 14.57 in.



Trim Hip & Ridge

Overall length 400 mm, 15.75 in.
Length of cover 370 mm, 14.57 in.



Bender



Cutter



Flatsheet

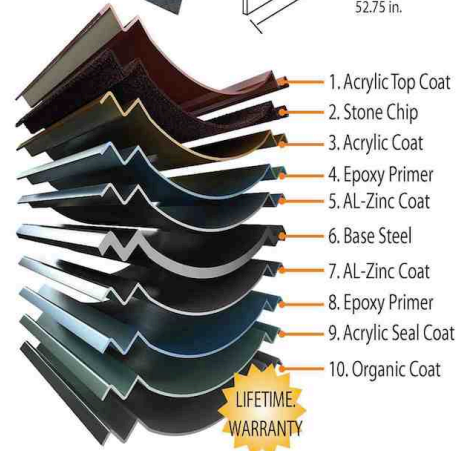
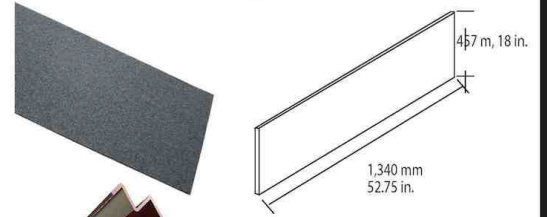

Installation Guide

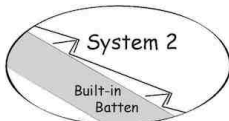

Shake FW



Slate FD



DaVinci FV



Starter/Eave

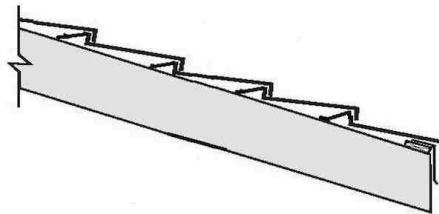
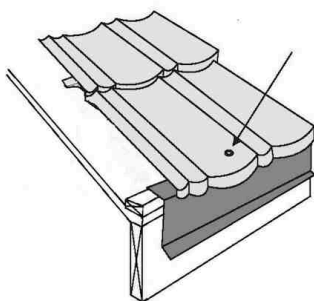

Rake/Gable

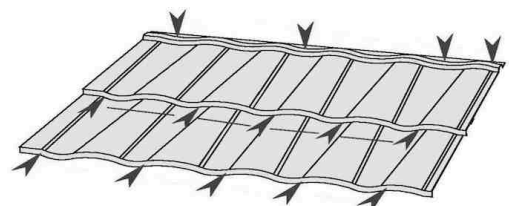
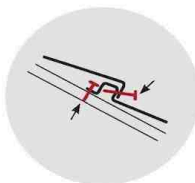
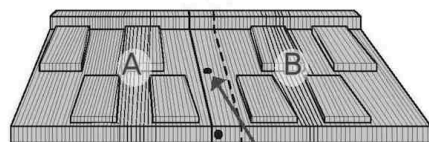
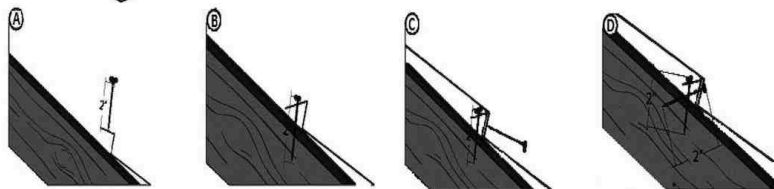
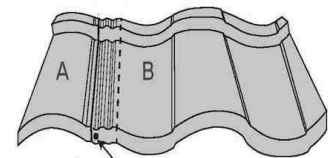
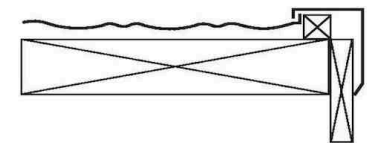
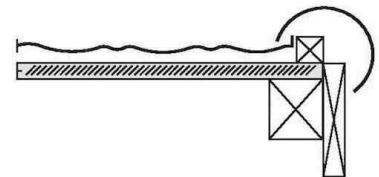

Installation Guide

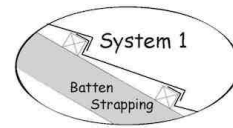

Tile FR Shake FW Slate FD Tile 2 FZ



Starter/Eave Rake/Gable

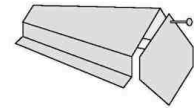
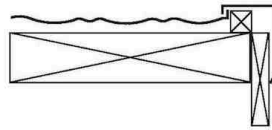
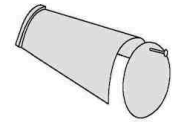
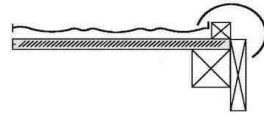
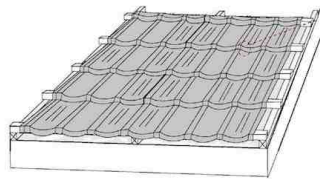
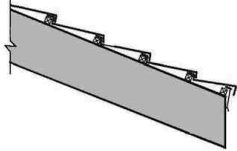
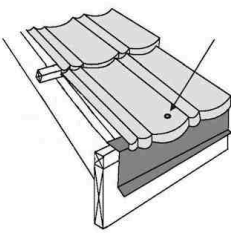

Valley Hip/Ridge

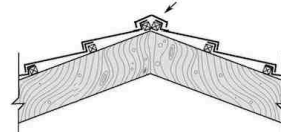
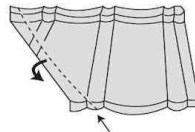
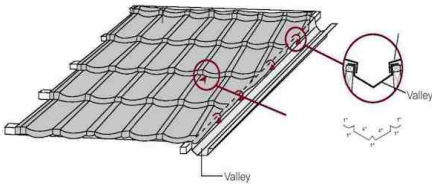
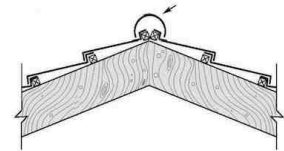
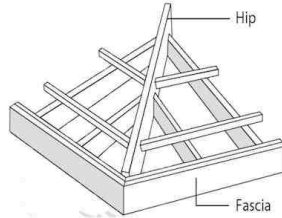
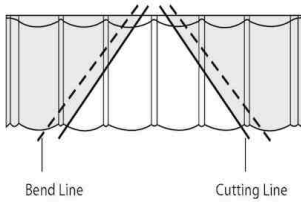
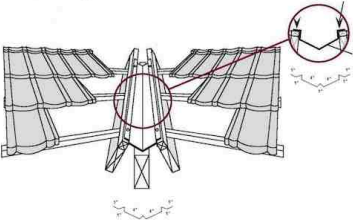

Fasteners Roof - to - Wall

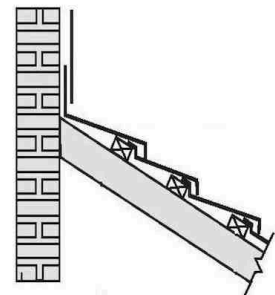
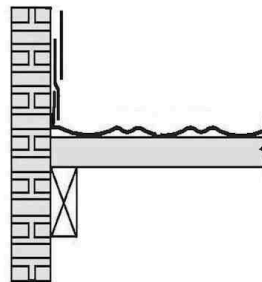
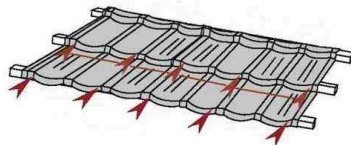
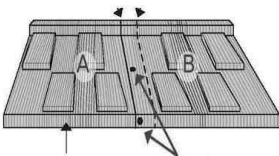
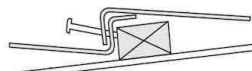
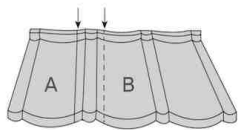

Metstar Building Products Inc. 340 Main Street East E,
 Hamilton, ON L8N 1J1
 Metstar USA 18168 Sundowner Way, Suite 1016,
 Canyon Country, CA 91387-4382 USA
 1-866-921-7122