

# THE PERFORMANCE SERIES

THE RESIDENTIAL METAL ROOFING COLLECTION BY VICWEST

# SUPERVIC / ULTRAVIC

## Installation Manual

[vicwest.com](http://vicwest.com)



*Vicwest Building Products*  
*Building for Tomorrow*

# THE PERFORMANCE SERIES

THE RESIDENTIAL METAL ROOFING COLLECTION BY VICWEST

<b>Table of Contents</b>	<b>Page(s)</b>
<b>Important Notices</b>	<b>3</b>
<b>Residential Roofing Application</b>	<b>4</b>
<b>Trims &amp; Accessories</b>	<b>5</b>
<b>Trim Glossary</b>	<b>6, 7, 8, 9</b>
<b>General Installation Recommendations</b>	<b>10</b>
<b>Installation Guidelines</b>	
<b>Roof Preparation</b>	<b>11</b>
<b>Fascia Details</b>	<b>12</b>
<b>Valley Details</b>	<b>12</b>
<b>Overlap &amp; Fastening Details</b>	<b>13</b>
<b>Ridge Cap Details</b>	<b>14</b>
<b>Vented Foam Closure</b>	<b>14</b>
<b>Cottage Hip Detail</b>	<b>15</b>
<b>Options for Snow Restraints</b>	<b>15</b>
<b>Chimney Flashing Details</b>	<b>16</b>
<b>Dektite® Combo Flashing</b>	<b>17</b>
<b>Warranty</b>	<b>18</b>



## Important Notices

This installation manual is a step by step procedure for roofing a residence and is intended to clearly depict to the installation professional recommended techniques and procedures to confidently estimate and install a SuperVic or UltraVic roof system. Great care must be taken to use the proper flashings and fittings to insure a perfect, long lasting, leak proof roof. Many inexperienced applicators try to cut corners but the end result is a roof that fails! Please follow this guide and if you have any questions, contact your Vicwest Dealer for further information. Vicwest offers this installation as a guideline only and assumes no responsibility whatsoever regarding improper installation or improper use of its products.

1. Due to the galvanizing process, the appearance of the spangles may vary considerably from one coil to another; this does not affect the quality of the zinc coating.
2. Due to pacification, GALVALUME™ may darken in appearance as it weathers. This does not affect the life-expectancy of the material.
3. Galvanized steel must be stored in a dry place and in such a manner as to allow air circulation between the sheets in order to avoid condensation. Wet sheets must be separated and allowed to dry to avoid white rust.
4. Vicwest recommends the use of a TurboShear power shear and or metal snips for cutting steel. If you wish to use a saw, the following precautions must be taken;

- (a) Use a circular saw in good condition with metal cutting blades. We do not recommend using abrasive cutting discs.
- (b) Cut sheets away from bundles and installed material so that hot filings do not damage painted surfaces.
- (c) Use shears to remove burrs from sheets, particularly where they have been cut at an angle.
- (d) Pre-painted material must be cut finished paint side down, i.e., with the pre-painted side to the floor.

5. Storage Stain: Storage Stain composed of white rust or blackening, caused by moisture and sometimes atmospheric elements trapped between bundled sheets, is a continuing problem. This moisture can be caused by rain, snow or condensation created by changing temperatures. Vicwest cannot control these conditions, and therefore cannot be responsible for the resulting problem. This responsibility is yours, and in order to minimize and attempt to eliminate the problem, we recommend the following precautions;

- (a) Always unload in dry weather or keep the material covered while unloading into a well ventilated building.
- (b) Inspect shipment immediately. If sheets are already wet, sign the freight bill accordingly and file a claim with the carrier.
- (c) Store all materials indoors.
- (d) If sheets should get wet, break the bundles and separate the sheets. If space is a problem, stand the sheets on end, strapped at the top and fanned out at the bottom for both drainage and ventilation.

### Colour Variations

It is important to order all the material for a project at the one time as shade consistency between batches cannot be guaranteed, due to normal manufacturing tolerances. This is applicable for Galvalume also.

### Fastening into Pressure Treated Wood

Based on recommendations received from our suppliers, all fasteners exposed to the new preservative formulations in pressure treated lumber must be of stainless steel.

### REMEMBER, ON ALL APPLICATIONS

1. Always use screws, not nails.
2. Use a proper screw gun, not a drill with a socket. Impact guns can remove finish from screw heads.
3. Use the proper flashing around the vents.
4. Flash all exposed edges with standard or custom flashing available from Vicwest.
5. All cutting of steel should be done on reverse side of sheet. Ensure that all metal filings are wiped clean from sheet.
6. Recommended cutting tools: circular saw with metal cutting blade, electrical nibblers or shears, tin snips for around chimney.

*Before proceeding with such an installation, always consult your local building inspector. Vicwest offers this installation as a guideline only and assumes no responsibility whatsoever regarding improper installation or improper use of its products.*

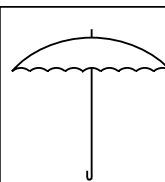

**KEEP DRY PRIOR  
TO INSTALLATION**

**WET PANELS MUST  
BE SEPARATED TO DRY!**

# THE PERFORMANCE SERIES

THE RESIDENTIAL METAL ROOFING COLLECTION BY VICWEST

## Residential Roofing Application

### SuperVic

A 30" coverage panel with a 3/4" rib. SuperVic's greater strength permits spans of up to 24". Minimum recommended pitch is 4:12. A fully reversible sheet, with little or no waste, makes a perfect panel for roofs with valleys, cottage hips or dormers.

#### Product Overview

Panel Lengths:	Min 4' (1219.2 mm) Max 35' (10668 mm)
Panel Width:	30" (762 mm)
Weight per linear foot:	2.08 lbs (28 ga.) 2.41 lbs (26 ga.)
Panel Exposure:	5.2 ft <sup>2</sup> (0.48 m <sup>2</sup> )
Available Gauge(s):	26 ga., 28 ga.      Application: Roof/Wall
	Pre-painted or Galvalume™

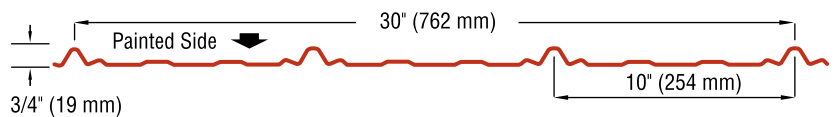
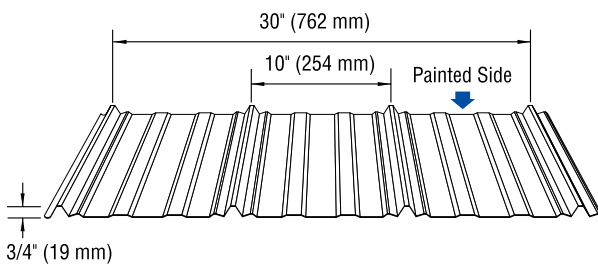
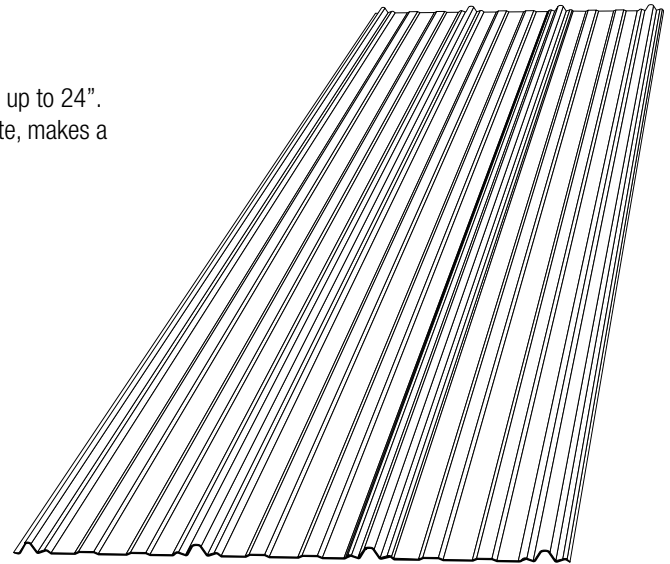

### UltraVic

A 36" coverage panel with a 3/4" rib. UltraVic is a very economical panel to use on straight gable roofs. Minimum recommended pitch is 4:12.

#### Product Overview

Panel Lengths:	Min 4' (1219.2 mm) Max 36' (10973 mm) (may vary by location)
Panel Width:	36" (914 mm)
Weight per linear foot:	2.1 lbs (29 ga.)
Panel Exposure:	5.2 ft <sup>2</sup> (0.48 m <sup>2</sup> )
Available Gauge(s):	29 ga.      Application: Roof/Wall
	Pre-painted or Galvalume™

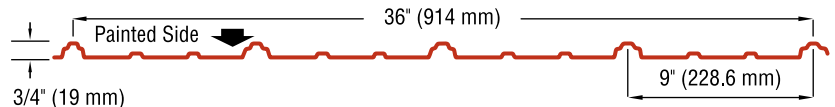
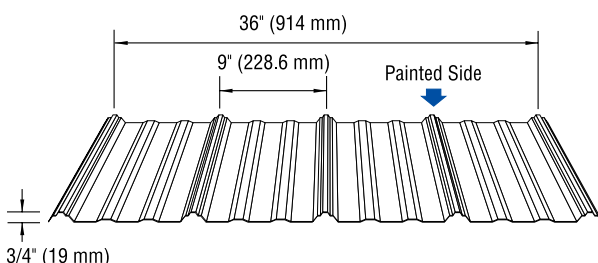
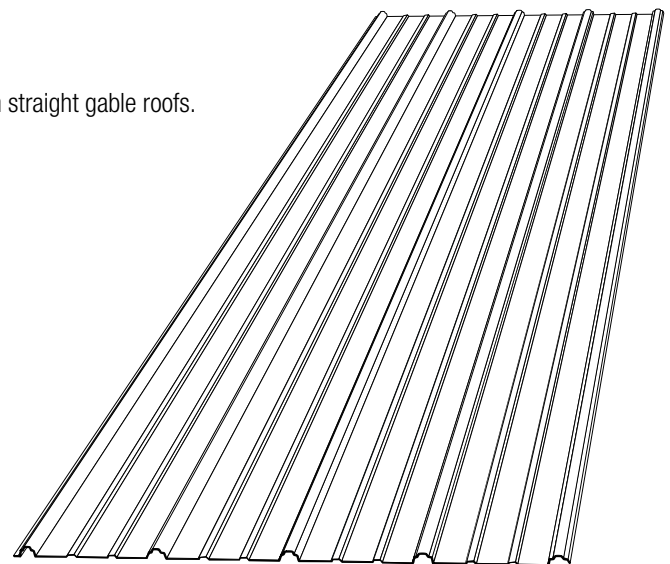

# THE PERFORMANCE SERIES

THE RESIDENTIAL METAL ROOFING COLLECTION BY VICWEST

## Trims & Accessories

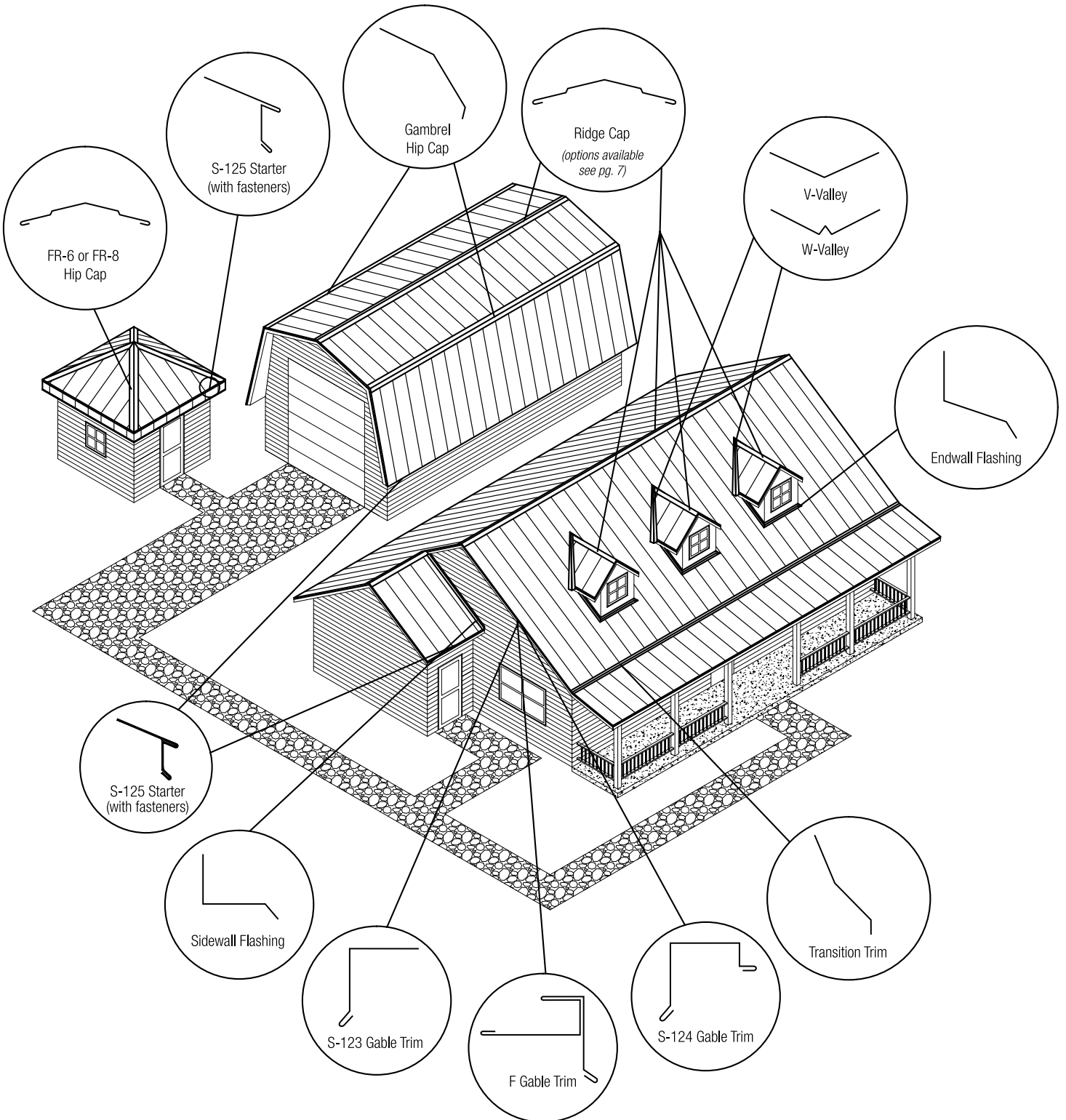

# THE PERFORMANCE SERIES

THE RESIDENTIAL METAL ROOFING COLLECTION BY VICWEST

## Trim Glossary

Note: Arrows on drawings indicate painted side of trim.

TRIM/ACCESSORY			DESCRIPTION
Ridge/Cottage Hip Cap FR-6			Pre-painted or Galvalume™ 10'-0" (3048 mm)
Ridge/Cottage Hip Cap FR-8			Pre-painted or Galvalume™ 10'-0" (3048 mm)
VMC Ridge Cap			Pre-painted or Galvalume™ 10'-0" (3048 mm)
F Gable Trim			Pre-painted or Galvalume™ 10'-0" (3048 mm)
S-125 Eave Trim			Pre-painted or Galvalume™ 10'-0" (3048 mm)
S-124 Gable Trim			Pre-painted or Galvalume™ 10'-0" (3048 mm)
S-123 Gable Trim			Pre-painted or Galvalume™ 10'-0" (3048 mm)
S-122 Gable Trim			Pre-painted or Galvalume™ 10'-0" (3048 mm)
V-Valley			Pre-painted or Galvalume™ 10'-0" (3048 mm)
W-Valley			Pre-painted or Galvalume™ 10'-0" (3048 mm)

# THE PERFORMANCE SERIES

THE RESIDENTIAL METAL ROOFING COLLECTION BY VICWEST

## Trim Glossary

Note: Arrows on drawings indicate painted side of trim.







TRIM/ACCESSORY		DESCRIPTION	
Transition/Reversed Hip Cap		Pre-painted or Galvalume™ 10'-0" (3048 mm)	
Sidewall Flashing			Pre-painted or Galvalume™ 10'-0" (3048 mm)
Endwall Flashing			Pre-painted or Galvalume™ 10'-0" (3048 mm)
Chimney Flashing #1			
Chimney Flashing #2			
Chimney Flashing #3			
Dektite® Combo Flashing		#3 flashing fits pipe sizes of 1/4" to 5" in diameter	
Valley & Hip Sealer		1" x 2" x 13' 1-1/2"	
Metal Building Tape		1/8" x 1/2" x 25' long	

# THE PERFORMANCE SERIES

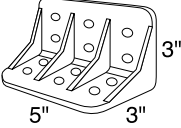
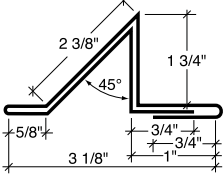
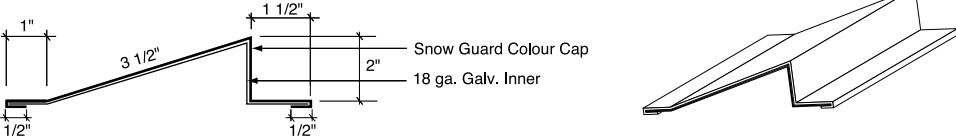
THE RESIDENTIAL METAL ROOFING COLLECTION BY VICWEST

## Trim Glossary

Note: Arrows on drawings indicate painted side of trim.

TRIM/ACCESSORY	DESCRIPTION
Polar Blox	
1-piece Snow Guard	
2-piece Snow Guard	
SuperVic Vented Foam Closures	 <p data-bbox="1292 957 1382 984">2'6" long</p>
UltraVic Vented Foam Closures	 <p data-bbox="1292 1115 1382 1142">3'0" long</p>
Large Tab (for use above profile)	
Small Tab (for use below profile)	
Ridge End Seal	
Sealant	 <p data-bbox="1260 1755 1409 1782">Colour Matched</p>



# THE PERFORMANCE SERIES

THE RESIDENTIAL METAL ROOFING COLLECTION BY VICWEST

## Trim Glossary

TRIM/ACCESSORY	DESCRIPTION
Vicwest Synthetic Underlayment	48" x 250' roll covers 1000 sq. ft.
*Vicwest Self Adhering Underlayment	36" x 66.7' covers 200 sq. ft.
* Vicwest Self Adhering Underlayment is strongly recommended to cover 3' of roof perimeter and on all hips and valleys	
Woodgrip Screws	#9 x 1" (25.4 mm) Colour Matched
Woodgrip Screws	#9 x 2" (50.8 mm) Colour Matched

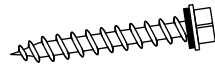

### RECOMMENDED TOOLS



TSHD Turbo Shear

## General Installation Recommendations

Do not screw top sheet of roofing until ridge cap is applied — then screw through both the ridge cap AND the sheet at the high part of the rib.

At gable end, extend sheets 1" beyond gable fascia and soffit.

Overlap sheet ends by at least 6" — lay sheets one by one from eave to ridge before starting new row.

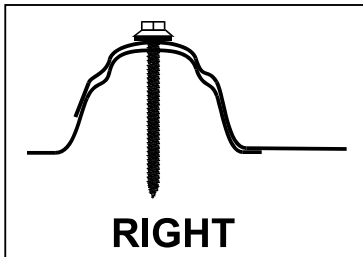

### CAUTION!

Panels must be lapped properly;  
lap with short leg on top.

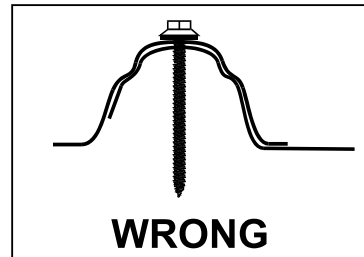

Do not secure all fasteners on panel until sheet has been laid and squared, to ensure an even application of all sheets.

Start roof steel application at end of roof farthest from prevailing winds and overlap next rows of sheeting over those already applied.

Extend ends of roof sheets approximately 1" past finished sidewall fascia and soffit.

Over-torquing of fasteners can cause distortion of roofing profiles and thus make proper overlapping impossible — under-torquing can cause leaks and undue wear on the sheet of steel.

Do not fasten open side rib before starting new row. Fastener must secure both underlap and overlap ribs in one operation.

Roof purlin spacing varies with the gauge of steel, profiles of roofing used, snowloads and pitch of roof. It is important that the applicator make himself aware of all criteria pertaining to the installation of a roofing system and, if necessary, verify these criteria with the local Building Inspector.

As a general rule for estimating purposes, 85 neoprene washer head screws are sufficient for the application of one square of roofing steel.

## Installation Guidelines

### Roof Preparation

Draw a diagram of the roof or structure that you will be installing. To accurately estimate and order your new Vicwest product, all measurements must be precise and included on your drawing. Include all valley lengths, cottage roof hip lengths, dormer sizes, rafter (measure from centre of ridge to outside of fascia board; do not deduct from this measurement) and ridge lengths, and the location and sizes of all chimneys, skylights and vent pipes. It is also important to know the approximate pitch of your roof, as it is imperative that flashings and ridge vents be made to suit.

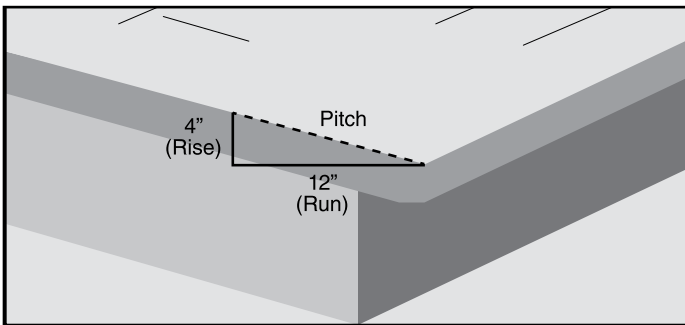
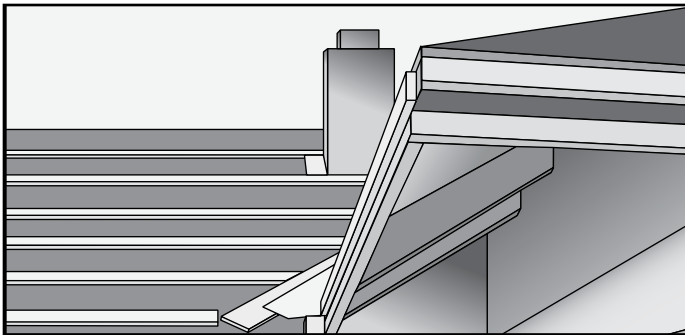

To determine the pitch of the roof, measure horizontally across the gable end and mark a distance of 12". From this point, measure the vertical rise of the roof. This will give you the pitch; e.g., a 4" rise in 12" will be a 4:12 pitch. Have your Vicwest dealer estimate your requirements.

### New Roofs

On new roofs or where shingles are torn off, Vicwest recommends the sheathing be covered with Synthetic or Self Adhering Underlayment, the steel then being laid directly on the underlayment.

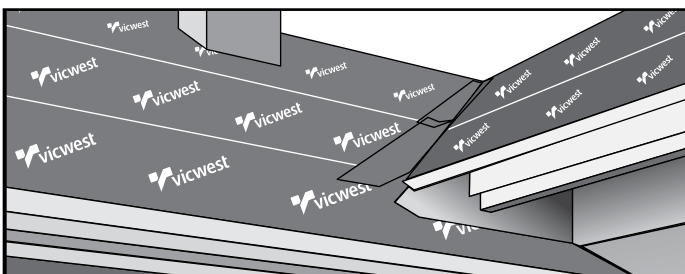

### Re-roofing

Once you have received your new Vicwest panels and accessories, you are ready to proceed with the application. Cut off the overhanging old roofing flush with the fascia. Replace or repair any damaged or deteriorated fascia boards. Check the structural integrity of the roof framing and repair any areas requiring attention.

Using a minimum of 1" x 4" standard or better lumber, install strapping around pipes that protrude through the roof. Check the Dektite® Combo Flashing section on page 16 for the location of the strapping. Then install strapping down the valleys and along ridges, hips and any other place where a flashing will be required. In each case, check the flashing for the proper location of the strapping. If snow restraint is required, check the detail on page 15 and locate strapping accordingly.

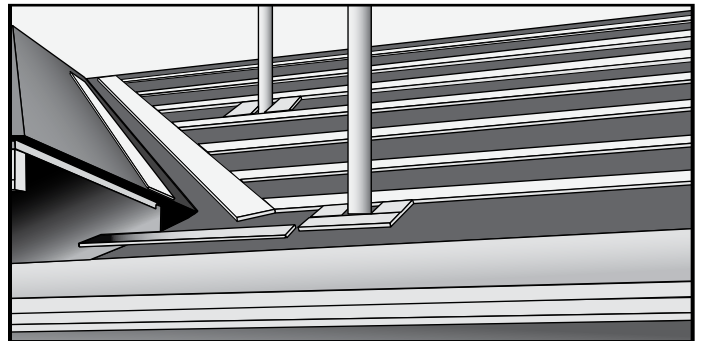

Strap the rest of the roof with a minimum of a 1" x 4" standard or better lumber, placed at proper spans. Span information is available from your Authorized Vicwest Dealer. It is recommended that strapping be screwed to the roof as nails will pull out after a time. Be sure that all strapping is level - shim under the strapping where necessary.

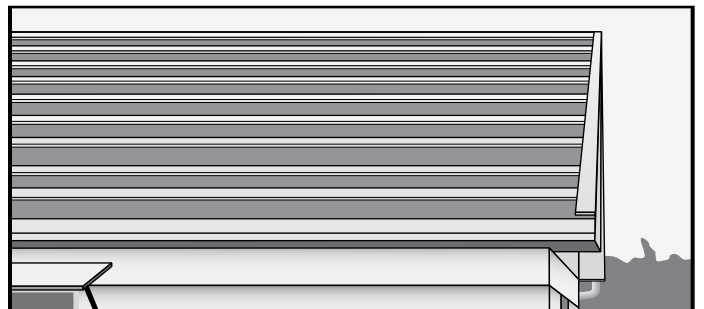

# THE PERFORMANCE SERIES

THE RESIDENTIAL METAL ROOFING COLLECTION BY VICWEST

## Fascia Details

Install the fascia cover flashings on eaves and gables. These are usually an S-122 for the eaves and an S-123 for the gables.

### S-123 Gable Cap Detail

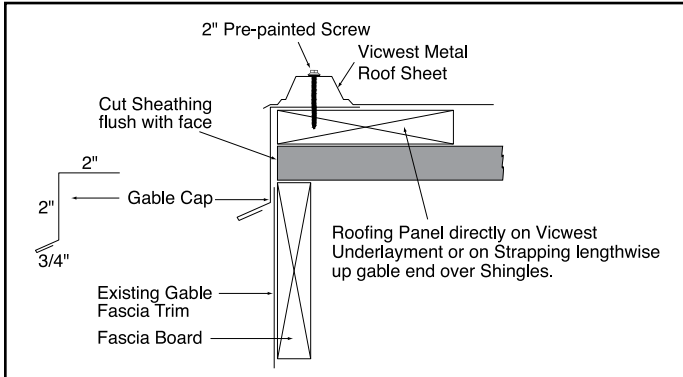

### S-122 Eave Cap Detail

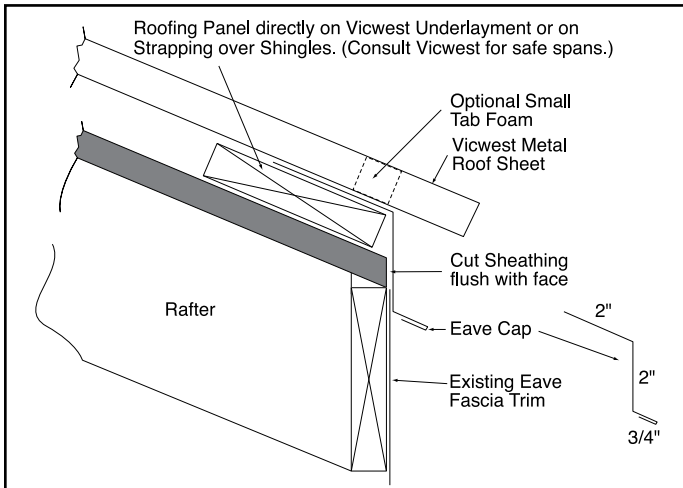

## Valley Details

Install the valley flashings using small galvanized nails to hold them in place. Screws will be applied later, securing them permanently. Valley and Hip Sealer should be installed 4 to 6" up from the centre of the valley. This will ensure a water-tight joint.

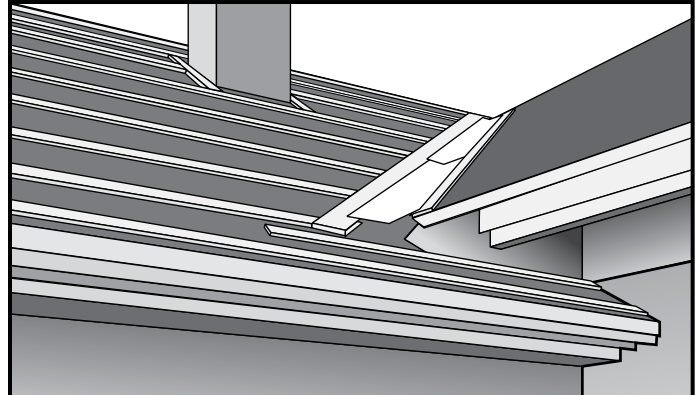

### W-Valley Detail

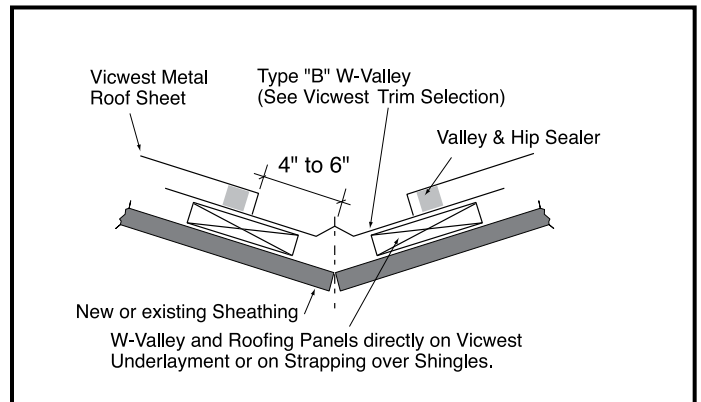



# THE PERFORMANCE SERIES

THE RESIDENTIAL METAL ROOFING COLLECTION BY VICWEST

## Overlap and Fastening Details

Begin to apply the sheets. Be sure to start your sheets square, and in the case of UltraVic, lapping the short lap over the full lap, as per specifications. It is recommended that you pre-drill your sheets where possible, by measuring the centres on your strapping and marking the sheets accordingly. This procedure will give you an aesthetically pleasing look, as you will have straight rows of screws on the finished roof. Always pre-drill and cut the sheets from the back side, ensuring that all metal filings are wiped from the sheet. Apply the sheets with pre-painted screws. Great care must be taken that the washer is compressed but not over-tightened, as shown in the diagram opposite.

**Note:** Lap joints should face away from prevailing winds. As you proceed across the roof, install flashings as required.

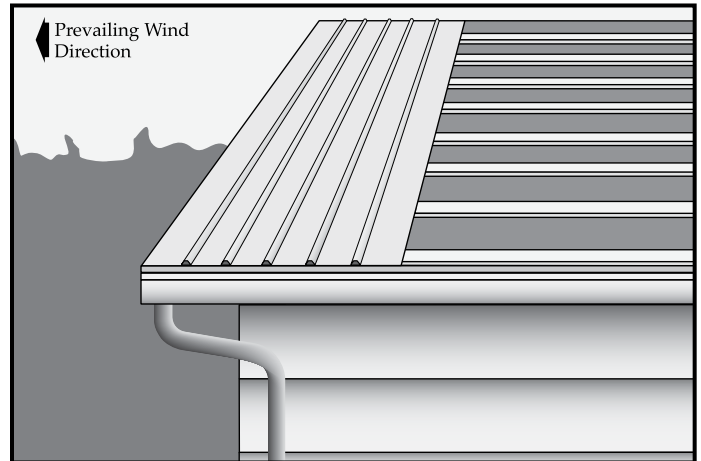

### SuperVic

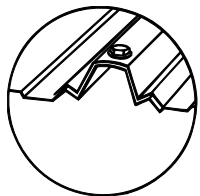
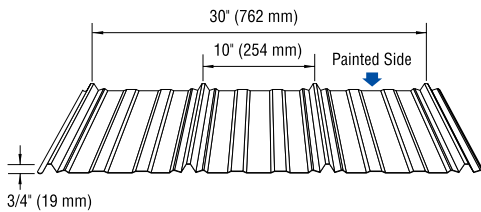

*Recommended Overlap Procedure*

### UltraVic

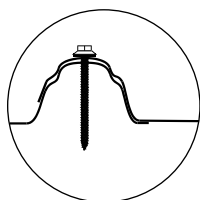
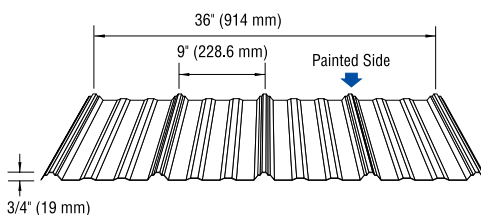

*Antisiphon Overlap Procedure*

Structural Fastener: Fasten panel to structural through crown of sheet.

Structural Fastener: Fasten panel to structural through flat of sheet.

Prevailing Wind Direction

Follow panel manufacturer's recommendations for proper fastener placement.

Apply sufficient torque to seat the washer.  
**NOTE: Do not over-drive the fastener!**

COMPRESSION		
CORRECT	TOO LOOSE	TOO TIGHT
Sealing material slightly visible.	Sealing material not visible.	Metal Washer deformed.

# THE PERFORMANCE SERIES

THE RESIDENTIAL METAL ROOFING COLLECTION BY VICWEST

## Ridge Cap Details

Fasten ridge cap using pre-painted screws at each rib. The use of venting foam closure (over sheet) is highly recommended between the cap and the sheet.

### Vented Foam Closure Installation

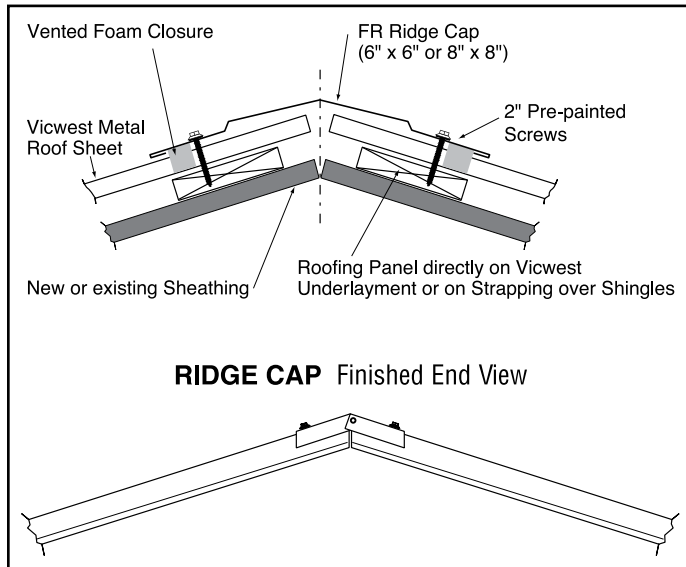

**Note:** Vicwest's Foam Closure for SuperVic and UltraVic is a must on any roof application.

The building code requires proper ventilation and Vicwest strongly supports this, as poor ventilation is the major cause of condensation in an attic!

## Vented Foam Closure

### Features & Benefits

Vicwest Vented Foam Closure is designed to fit underneath your Ridge Cap, giving a clean unobtrusive appearance. It provides 4.5 sq. inches of free air intake per lineal foot of closure or 9 sq. inches per lineal foot of ridge.



**Note:** This Closure can be combined with our Residential Endwall RE-8 to create a Ventilated Endwall.

### INSTALLATION

- 1) Keep your roof sheet back 2" from the ridge line.
- 2) Peel paper from glue line on vented foam closure.
- 3) Place vented closure on panel.
- 4) Install ridge cap. Fasten with a pre-painted screw on every rib.

# THE PERFORMANCE SERIES

THE RESIDENTIAL METAL ROOFING COLLECTION BY VICWEST

## Cottage Hip Detail

If re-roofing over shingles, strap up each side of the hip, checking the flashing (hip cap) for proper placement.

Cut the angle required on the steel panel and install on the hip. Apply Valley & Hip Sealer down both sides of the hip and screw the hip cap on, using a pre-painted screw at each rib as shown on the drawing.

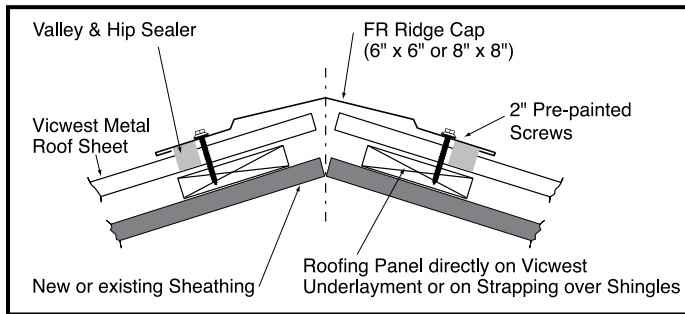

## Transition Trim

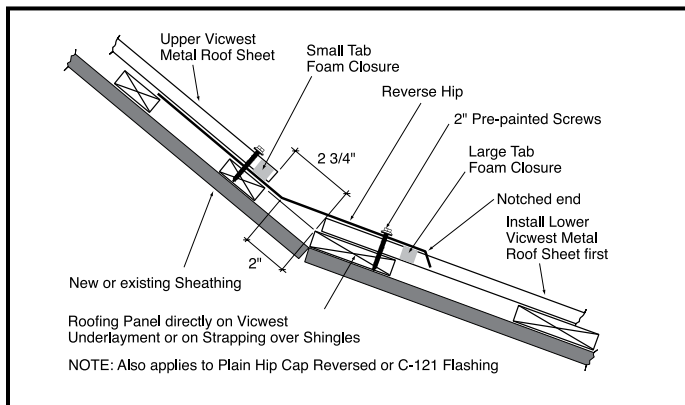

## Options for Snow Restraints

Drifts of snow and ice accumulating on top of homes may suddenly cascade down and off roofs. This can tear off gutters and cause injuries to people or damage objects below.

The potential for snow pile-up on a roof can vary greatly, depending on building location and geometry. If significant loading is expected on a restraining system, an engineered system appropriately anchored to the building structure should be investigated. If minor loading is envisioned, one of the following options may be appropriate.

### 1. SNOW GUARDS

Snow guards may hold back or slow the movement of snow or ice.

#### Snow Guard

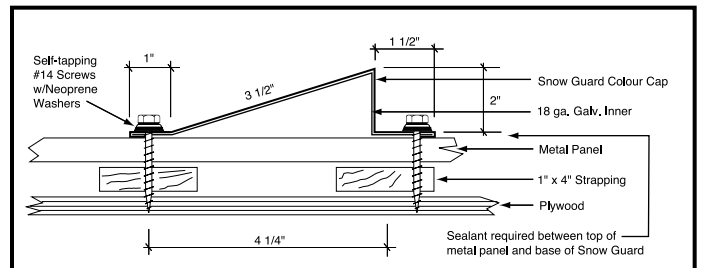

### 2. POLAR BLOX

This polycarbonate product is intended to solve the problem of ice and snow movement. This item must be installed in accordance with the manufacturer's directions:

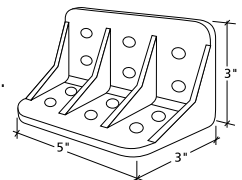

1) Apply a transparent silicone sealant to the base (nonacetic acid type on Galvalume or Galvanized roofs).

2) Using 2 self-tapping #14 screws w/neoprene washers, screw through the Polar Blox and roofing material into the purlin or structural support.

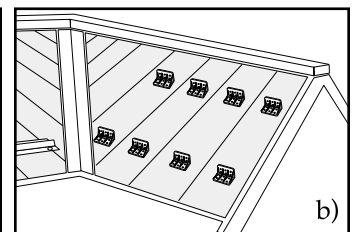
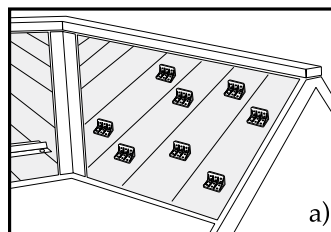
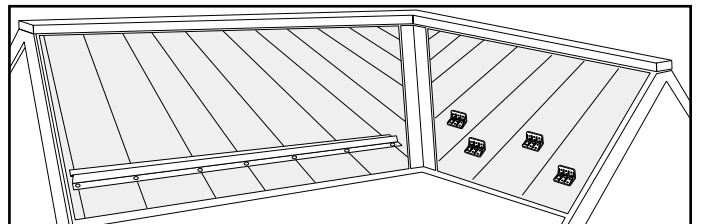

a) Slope 3/12 to 6/12: 1 staggered row every 25' of roof length. 2' max. on centre horizontally.

b) Slope over 6/12: 1 straight row every 12' of roof length. 1' max. on centre horizontally.

## Chimney Flashing Details

It is recommended that, when a brick chimney is present in a re-roof application when using SuperVic or UltraVic, a saddle be built on the back of the chimney to deflect snow and water around the chimney.

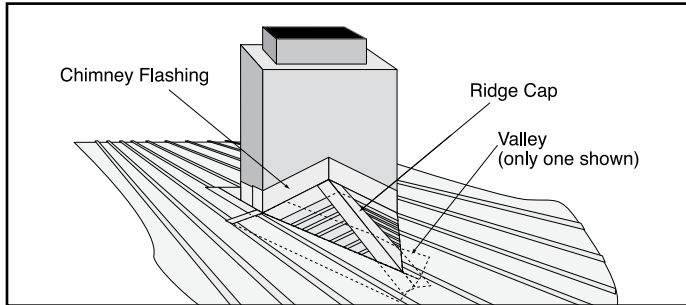

## Chimney Flashing #2

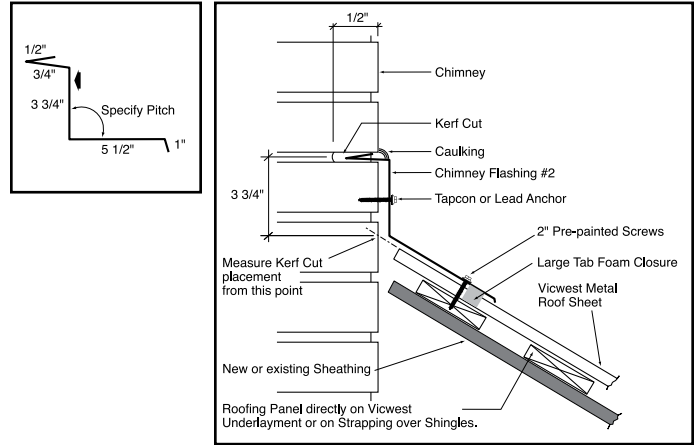

This installation involves cutting a 1" deep slot in the brick with a concrete diamond blade. Install chimney flashing #2 as shown in diagram. Fasten to chimney with Tapcon or lead anchor fasteners.

## Optional Chimney Flashings

### Chimney Flashing #1

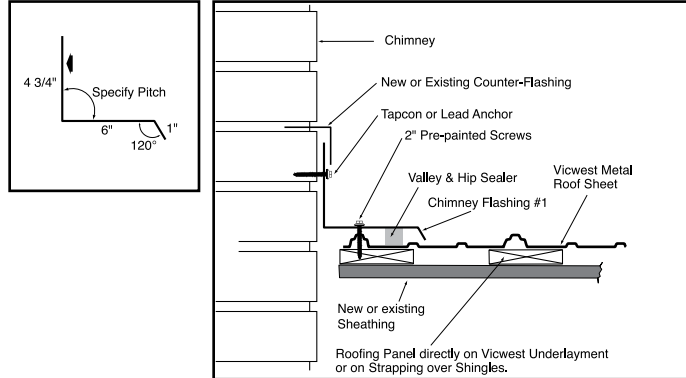

Cut existing chimney flashing. Slide nailer of chimney flashing #1 up underneath new or existing Counter-Flashing. Note that the wall nailer may have to be trimmed to fit. Fasten to chimney with Tapcon or lead anchor fasteners.

### Chimney Flashing #3

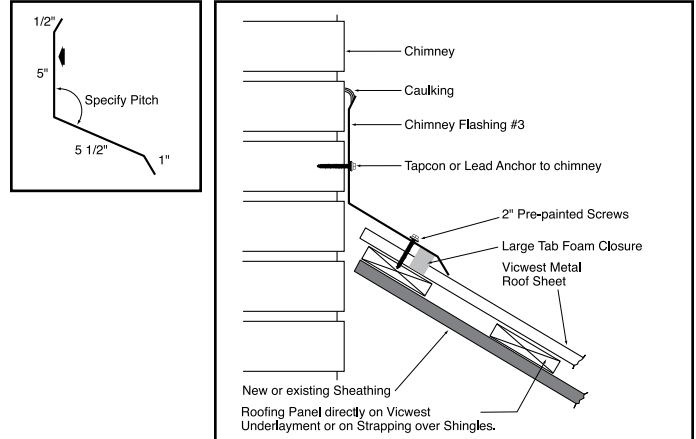

Install as shown. Fasten to chimney with Tapcon or lead anchor fasteners.



# THE PERFORMANCE SERIES

THE RESIDENTIAL METAL ROOFING COLLECTION BY VICWEST

## Dektite® Combo Flashing

For use with hydro masts and vent pipes.

Cut to size, place bead of silicone around metal base from base to ribs or profile and then fasten with skirt flange screws.



- Standard flashing and retrofit flashing all in one
- When retrofit is required just add clips for easy application
- Internal cone design provides 1/2" of continuous contact
- Pipe OD markings clearly shown on cutting groves
- Large base design to improve sealing on high rib metal roof sheets
- 20 Year Warranty

Available in Black

(Grey EPDM & Red Silicone Available by Special Order)

EPDM will withstand constant temperatures at the roofline of -50°C (-122°F) to 115°C (239°F) & up to 150°C (302°F) intermittently.

Red Silicone will withstand constant temperatures at the roofline of -50°C (-122°F) to 200°C (392°F) & up to 250°C (482°F) intermittently.

1. When used in retrofit application apply silicone to both seam & underside
2. Limited spacing may occur between clips
3. Fasten clips using multigrips, working from top to base
- 4 Fasten combo base by placing a fastener either side of clips first

\*Always use the neutral base low modulus silicone for sealing

\*\*In corrosive and coastal environments fix blind aluminum rivets

## Dektite® Combo Flashing Installation

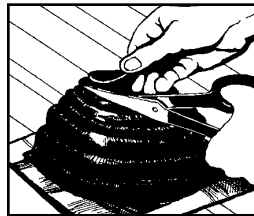

1. TRIM - Cut opening 20% smaller than pipe diameter.

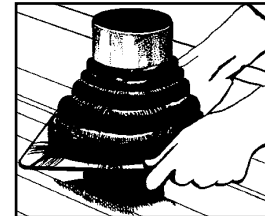

2. SLIDE - Slip Dektite® Combo Flashing over pipe.

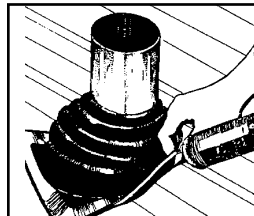

3. SEAL - Apply urethane / silicone sealant between Dektite® Combo Flashing and roofing.

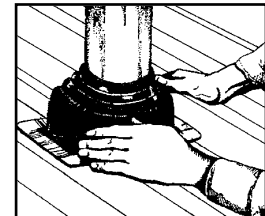

4. FORM - Bend aluminum base to fit irregularities. Use large slot screwdriver to press into tight angles.

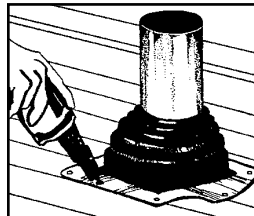

5. FASTEN - Complete the seal using common weather-resistant fasteners.

CODE	DESCRIPTION	PIPE SIZE METRIC	PIPE SIZE IMPERIAL	ROOF PITCH	BASE MM	INCHES	COLOURS	MAX # OF DC CLIPS (TWINS) REQUIRED
DC103	Dektite® Combo #3	5-127 mm	1/4" - 5"	0-40° or 10/12	216 x 216 mm	8 1/2" x 8 1/2"	Black	4

# THE PERFORMANCE SERIES

THE RESIDENTIAL METAL ROOFING COLLECTION BY VICWEST

## Warranty Registration

Homeowners can register product warranties online at [www.vicwestwarranty.com](http://www.vicwestwarranty.com)

Upon receipt of your registration, Vicwest will forward by email the warranty with certificate number. The homeowner should keep this information in a safe place for future reference or in the event they need to submit a claim or wish to transfer the warranty where applicable.

For information on available colours and finishes please visit [www.vicwest.com](http://www.vicwest.com)

## Disclaimer

It is the sole responsibility of the contractor to ensure installation is completed according to the directions herein, and that all construction by-laws and codes are met. The recommendations in the printed and the video versions of the installation guide are based on Vicwest's continuing program of laboratory testing, product research and comprehensive field experience. Vicwest does not and cannot cover damage of any kind resulting from faulty or improper installation.

In accordance with ongoing efforts to improve our products and their performance, Vicwest Building Products reserves the right to change, without notice, the specifications contained herein.

The contents herein are for general information and illustrative purposes only and are not intended to serve as any type of advice. Every effort is made to ensure the accuracy of the information included in this brochure and it is believed that the information contained herein is accurate and reliable as of the date of publication. Vicwest Building Products, however, does not warrant or represent the accuracy or reliability of any information included in this brochure. Any reliance on any information without consultation with Vicwest Building Products or a duly authorized representative shall be at the user's own risk.

©2017, Vicwest Building Products – All rights reserved  
March 2017